

IMPORTANT SAFETY INFORMATION. READ AND FOLLOW ALL SAFETY INSTRUCTIONS. Follow label information and instructions concerning Wet or Damp Locations, installation near combustible materials, insulation, building materials, and proper lamping. Do not install in areas subject to combustible vapors or gases. Before wiring to power supply and during servicing or relamping, turn off power at fuse or circuit breaker. **All servicing or relamping must be performed by qualified service personnel. Product must be grounded to avoid potential electric shock or other potential hazard. Product must be mounted in locations and at heights and in a manner consistent with its intended use, and in compliance with the National Electrical Code and local codes.** The use of accessory equipment not recommended by the manufacturer or installed contrary to instructions may cause an unsafe condition. Do not block light emanating from product in whole or part, as this may cause an unsafe condition. Do not allow items such as drapes, curtains, screens or the like to come into contact with the product or to block light from the product, as this may cause an unsafe condition.

INSTALLATION INSTRUCTIONS 77

1. Assemble B-6 hangers by overlapping ends of two sections, placing tabs in square hole. Slide sections together, so tabs engage slots. (Fig. 1)
 2. Nail one B-6 bar hanger to ceiling joist or attach to suspended ceiling support member with clamps in Packet 94. (Standard 1 1/2" carrier channels can be used to install fixture).
 3. Attach other B-6 bar hanger to fixture by inserting in "C" bracket and prying locking tabs against bar. (FIG. 4)
 4. To install fixture, position other "C" bracket over the bar hanger in ceiling. (FIG. 5)
 5. Attach bar hanger on fixture to ceiling structure.
 6. Position fixture and lock in place by prying "C" bracket locking tabs against bar.
 7. Remove J-Box cover plate. Remove appropriate knockout and assemble appropriate connector for the supply wire used. Connect ground wires to green ground leads. Connect white (common) to white (leads). Connect power supply (line) to black lead(s). Reinstall J-Box cover.
- WARNING: DO NOT pinch wires between J-Box/ballast cover and J-Box. Consult a Qualified Electrician for all other options that require other wiring configurations.**
8. Finish Ceiling:
Wet ceiling per Fig. 5 & 6
Dry ceiling per Fig. 7 & 8
 9. Install reflector/trim. (Fig. 9 & 10)



Fig. 1

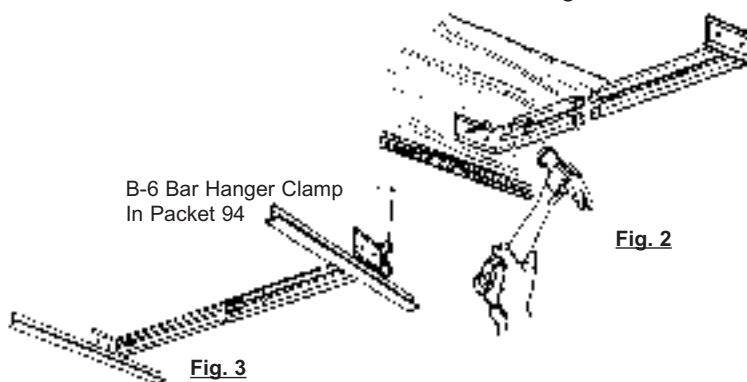

B-6 Bar Hanger Clamp
In Packet 94

Fig. 2

Fig. 3

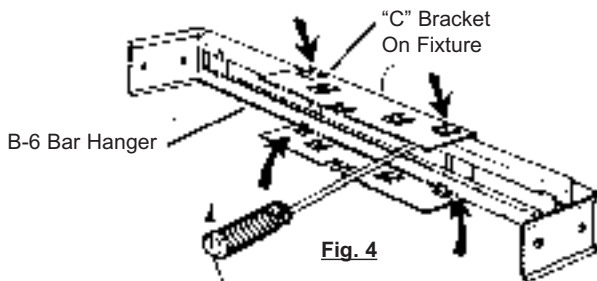

B-6 Bar Hanger

Fig. 4

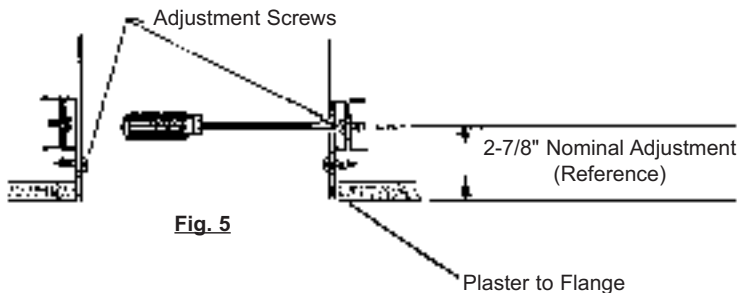

Fig. 5

Plaster to Flange

CAUTION:
Bottom edge of plaster flange must be even with finished ceiling surface.
To adjust to varying ceiling thickness, loosen screws retaining "C" brackets.
Raise or lower fixture and tighten screws. (Fig. 5)

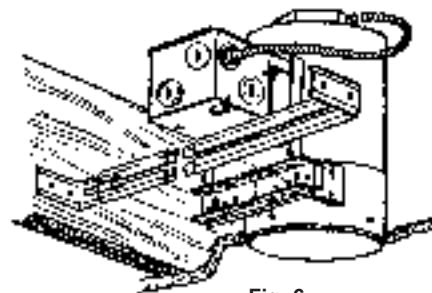

Fig. 6

SEE OTHER SIDE FOR DRY CEILING INSTALLATION AND REFLECTOR/TRIM INSTALLATION



DRY CEILING INSTALLATION

Position plaster flange so that it rests on top surface of ceiling.

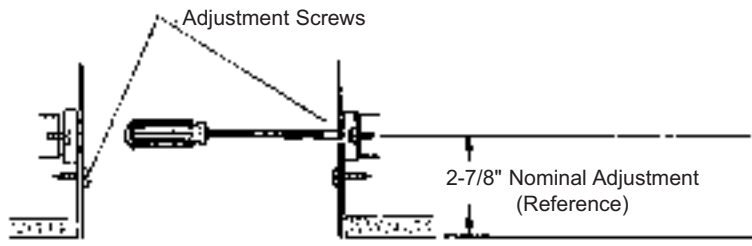

Fig. 7

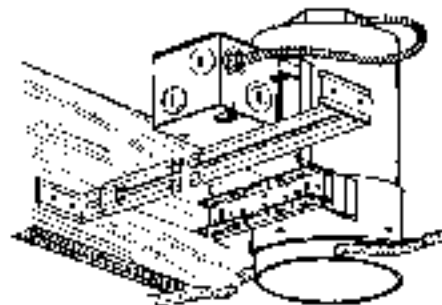

Fig. 8

Cut dry ceiling opening for: #77 & 77U — 4 3/8" dia.
 #79 & 79U — 6 1/8" dia.
 #84 & 84U — 8 1/8" dia.

CAUTION:

Bottom edge of plaster flange must be even with finished ceiling surface.
 To adjust to varying ceiling thickness, loosen screws retaining "C" brackets.
 Raise or lower fixture and tighten screws. (Fig. 7)

REFLECTOR INSTALLATION

1. Place ring over reflector. (Fig. 9)
2. Pull springs up & hook through slots in housing. (Fig. 10)

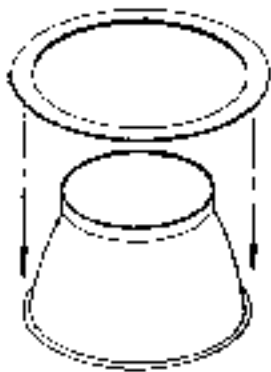

Fig. 9

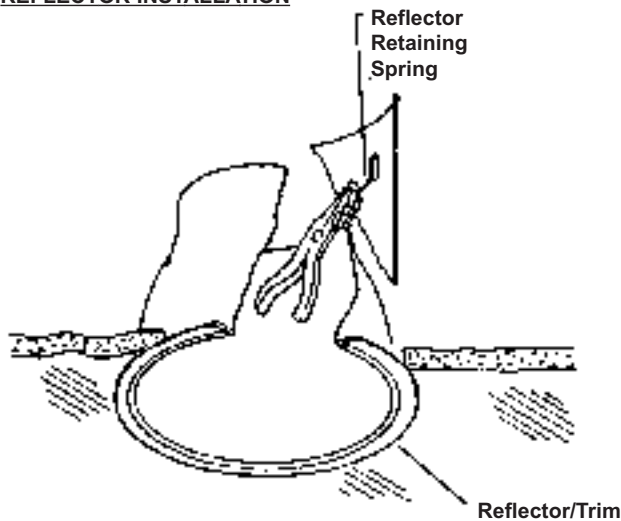

Fig. 10

